

NEW BLUE SERIES



POELSAN®



TS ISO 17885

KOD CODE	EBAT/SIZE d x G	AMBALAJ ADEDİ PACKING QUANTITY	KOLİ ADEDİ BOX QUANTITY	ÇUVAL ADEDİ SACK QUANTITY
10001011	20 x ½"	50	800	850
10001012	20 x ¾"	50	700	800
10001021	25 x ½"	25	550	550
10001022	25 x ¾"	25	500	500
10001023	25 x 1"	25	450	500
10001031	32 x ½"	25	300	350
10001032	32 x ¾"	25	300	325
10001033	32 x 1"	25	275	325
10001034	32 x 1 ¼"	25	250	300
10001043	40 x 1"	15	150	180
10001044	40 x 1 ¼"	15	150	180
10001045	40 x 1 ½"	15	150	165
10001054	50 x 1 ¼"	10	90	110
10001055	50 x 1 ½"	10	90	100
10001056	50 x 2"	10	90	100
10001065	63 x 1 ½"	6	60	66
10001066	63 x 2"	6	54	60
10001067	63 x 2 ½"	6	54	54
10001076	75 x 2"	4	32	36
10001077	75 x 2 ½"	4	32	32
10001078	75 x 3"	4	32	32
10001086	90 x 2"	4	20	20
10001087	90 x 2 ½"	4	16	20
10001088	90 x 3"	4	16	20
10001089	90 x 4"	4	16	20
10001095	110 x 2"	2	12	14
10001096	110 x 2 ½"	2	12	14
10001097	110 x 3"	2	12	14
10001098	110 x 4"	2	12	14



KABLİN ERKEK

MALE ADAPTOR

ΜΥΦΤΑ Σ ΗΑΡΥΧΗ. ΡΕ

س خرطوم سن خارجي

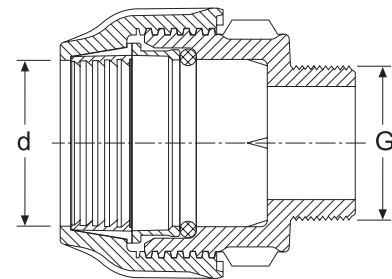



KABLİN MANŞON

COUPLING

МУФТА СОЕДИНИТЕЛЬНАЯ

وصلة خرطوم

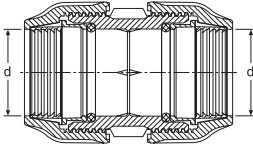

KOD CODE	EBAT/SIZE d x d	AMBALAJ ADEDİ PACKING QUANTITY	KOLİ ADEDİ BOX QUANTITY	ÇUVAL ADEDİ SACK QUANTITY
10002011	20 x 20	25	450	450
10002022	25 x 25	25	300	325
10002033	32 x 32	10	170	180
10002044	40 x 40	10	90	110
10002055	50 x 50	6	60	66
10002066	63 x 63	5	35	35
10002077	75 x 75	2	18	20
10002088	90 x 90	2	10	12
10002099	110 x 110	1	8	9



KABLİN TE

TEE

ТРОЙНИК

تی خرطوم

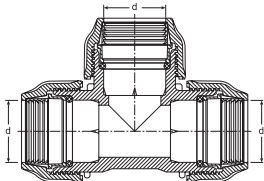

KOD CODE	EBAT/SIZE d x d x d	AMBALAJ ADEDİ PACKING QUANTITY	KOLİ ADEDİ BOX QUANTITY	ÇUVAL ADEDİ SACK QUANTITY
10002511	20 x 20 x 20	15	240	255
10002522	25 x 25 x 25	10	150	160
10002533	32 x 32 x 32	5	80	90
10002544	40 x 40 x 40	5	50	55
10002555	50 x 50 x 50	4	28	32
10002566	63 x 63 x 63	3	18	21
10002577	75 x 75 x 75	1	10	12
10002588	90 x 90 x 90	1	6	6
10002599	110 x 110 x 110	1	3	4

KOD CODE	EBAT/SIZE d x G x d	AMBALAJ ADEDİ PACKING QUANTITY	KOLİ ADEDİ BOX QUANTITY	ÇUVAL ADEDİ SACK QUANTITY
10003011	20 x 1/2" x 20	15	300	330
10003012	20 x 3/4" x 20	15	300	330
10003021	25 x 1/2" x 25	10	200	220
10003022	25 x 3/4" x 25	10	200	240
10003023	25 x 1" x 25	10	180	200
10003032	32 x 3/4" x 32	10	120	140
10003033	32 x 1" x 32	10	110	120
10003034	32 x 1 1/4" x 32	10	100	120
10003043	40 x 1" x 40	5	75	80
10003044	40 x 1 1/4" x 40	5	60	75
10003045	40 x 1 1/2" x 40	5	55	65
10003053	50 x 1" x 50	4	44	52
10003054	50 x 1 1/4" x 50	4	44	48
10003055	50 x 1 1/2" x 50	4	40	44
10003056	50 x 2" x 50	4	32	40
10003064	63 x 1 1/4" x 63	3	27	30
10003065	63 x 1 1/2" x 63	3	24	30
10003066	63 x 2" x 63	3	21	27
10003067	63 x 2 1/2" x 63	3	18	24
10003076	75 x 2" x 75	1	16	17
10003077	75 x 2 1/2" x 75	1	14	15
10003078	75 x 3" x 75	1	12	13
10003086	90 x 2" x 90	1	9	10
10003087	90 x 2 1/2" x 90	1	8	10
10003088	90 x 3" x 90	1	8	10
10003089	90 x 4" x 90	1	6	8
10003096	110 x 2 1/2" x 110	1	6	6
10003097	110 x 3" x 110	1	5	5
10003098	110 x 4" x 110	1	5	5



KABLİN ERKEK TE

MALE TEE

ТРОЙНИК С НАРУЖН.РЕ.З.

تي خرطوم سن خارجي

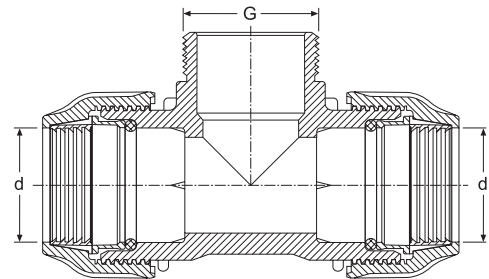



KOD CODE	EBAT/SIZE d x d	AMBALAJ ADEDİ PACKING QUANTITY	KOLİ ADEDİ BOX QUANTITY	ÇUVAL ADEDİ SACK QUANTITY
10004011	20 x 20	25	400	450
10004022	25 x 25	15	240	255
10004033	32 x 32	10	140	160
10004044	40 x 40	5	80	90
10004055	50 x 50	4	44	52
10004066	63 x 63	4	28	32
10004077	75 x 75	2	16	18
10004088	90 x 90	1	8	10
10004099	110 x 110	1	5	6

KABLİN DİRSEK

ELBOW

ОТВОД

زاوية خرطوم

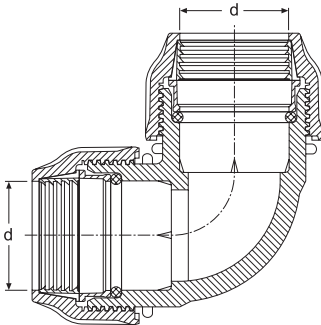

KOD CODE	EBAT/SIZE d x G	AMBALAJ ADEDİ PACKING QUANTITY	KOLİ ADEDİ BOX QUANTITY	ÇUVAL ADEDİ SACK QUANTITY
10004511	20 x ½"	25	600	700
10004512	20 x ¾"	25	550	600
10004521	25 x ½"	15	390	420
10004522	25 x ¾"	15	390	420
10004523	25 x 1"	15	330	360
10004532	32 x ¾"	10	240	250
10004533	32 x 1"	10	220	240
10004534	32 x 1 ¼"	10	200	200
10004543	40 x 1"	5	120	140
10004544	40 x 1 ¼"	5	120	130
10004545	40 x 1 ½"	5	110	125
10004554	50 x 1 ¼"	4	72	80
10004555	50 x 1 ½"	4	72	80
10004556	50 x 2"	4	64	72
10004565	63 x 1 ½"	4	44	52
10004566	63 x 2"	4	40	48
10004567	63 x 2 ½"	4	36	44
10004576	75 x 2"	2	24	28
10004577	75 x 2 ½"	2	24	24
10004578	75 x 3"	2	20	24
10004587	90 x 2 ½"	1	14	17
10004588	90 x 3"	1	14	17
10004589	90 x 4"	1	12	14
10004597	110 x 3"	1	8	11
10004598	110 x 4"	1	8	10



KABLİN ERKEK DİRSEK

MALE ELBOW

ОТВФД С НАРУЖН.РЕЗ.

زاوية خرطوم سن خارجي

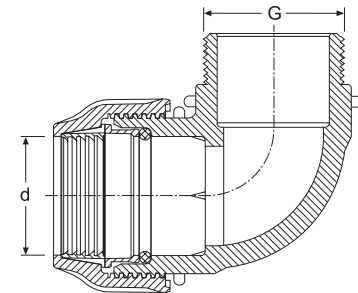



KABLİN REDÜKSİYON TE

REDUCING TEE

ТРОЙНИК ПЕРЕХОДНОЙ

تي خرطوم محول

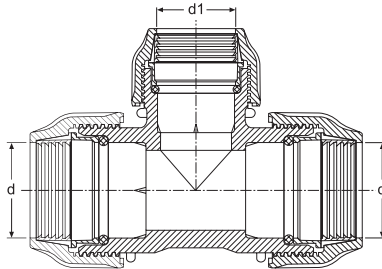

KOD CODE	EBAT/SIZE d x d, x d	AMBALAJ ADEDİ PACKING QUANTITY	KOLİ ADEDİ BOX QUANTITY	ÇUVAL ADEDİ SACK QUANTITY
10005521	25 x 20 x 25	10	180	200
10005531	32 x 20 x 32	5	120	120
10005532	32 x 25 x 32	5	100	115
10005542	40 x 25 x 40	5	65	75
10005543	40 x 32 x 40	5	55	65
10005552	50 x 25 x 50	4	40	44
10005553	50 x 32 x 50	4	40	44
10005554	50 x 40 x 50	4	40	40
10005563	63 x 32 x 63	3	24	30
10005564	63 x 40 x 63	3	21	24
10005565	63 x 50 x 63	3	21	24
10005575	75 x 50 x 75	1	14	14
10005576	75 x 63 x 75	1	12	14
10005586	90 x 63 x 90	1	8	9
10005587	90 x 75 x 90	1	7	8
10005596	110 x 63 x 110	1	6	6
10005598	110 x 90 x 110	1	4	5



KABLİN REDÜKSİYON MANŞON

REDUCING COUPLING

ПЕРЕХОДНИК

وصلة خرطوم محول

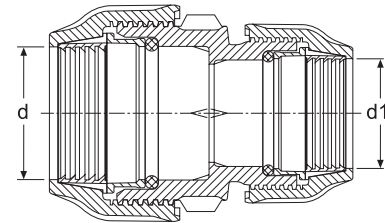

KOD CODE	EBAT/SIZE d x d ₁	AMBALAJ ADEDİ PACKING QUANTITY	KOLİ ADEDİ BOX QUANTITY	ÇUVAL ADEDİ SACK QUANTITY
10006021	25 x 20	25	350	400
10006031	32 x 20	10	240	270
10006032	32 x 25	10	200	240
10006041	40 x 20	10	150	170
10006042	40 x 25	10	140	160
10006043	40 x 32	10	120	130
10006052	50 x 25	6	90	102
10006053	50 x 32	6	84	96
10006054	50 x 40	6	72	78
10006062	63 x 25	6	54	60
10006063	63 x 32	6	48	60
10006064	63 x 40	6	48	54
10006065	63 x 50	6	36	48
10006075	75 x 50	2	28	32
10006076	75 x 63	2	24	24
10006086	90 x 63	2	14	18
10006087	90 x 75	2	12	16
10006097	110 x 75	1	8	11
10006098	110 x 90	1	8	10



KOD CODE	EBAT/SIZE d x d ₁	AMBALAJ ADEDİ PACKING QUANTITY	KOLİ ADEDİ BOX QUANTITY	ÇUVAL ADEDİ SACK QUANTITY
10006521	25 x 20	15	270	300
10006532	32 x 25	10	180	200
10006543	40 x 32	5	90	100
10006554	50 x 40	4	52	68
10006565	63 x 50	4	32	40
10006576	75 x 63	2	18	22
10006587	90 x 75	1	11	14
10006598	110 x 90	1	6	8

KABLİN REDÜKSİYON DİRSEK

REDUCING ELBOW
ОТВОД ПЕРЕХОДНОЙ
راوية خرطوم محول

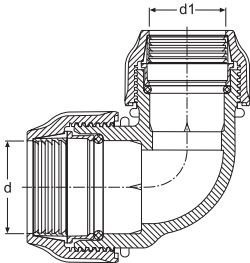



KOD CODE	EBAT/SIZE d	AMBALAJ ADEDİ PACKING QUANTITY	KOLİ ADEDİ BOX QUANTITY	ÇUVAL ADEDİ SACK QUANTITY
10007011	20	50	800	900
10007022	25	25	500	550
10007033	32	25	300	350
10007044	40	15	165	180
10007055	50	12	96	108
10007066	63	6	60	60
10007077	75	4	32	36
10007088	90	4	16	20
10007099	110	2	12	16

KABLİN KÖR TAPA

END CAP

ЗАГЛУШКА

راس نهاية خط

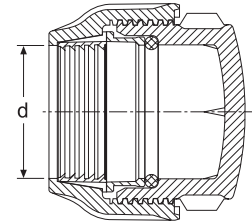



KABLİN DİŞİ

FEMALE ADAPTOR

МУФТА С ВНУТРЕН.РЕЗБ

زاس خرطوم سن داخلی

GALVANİZ METAL YÜZÜKLÜ

GALVANIZED REINFORCEMENT RING
Оцинкованное металлическое кольцо
حلقة معدنية مجلفنة سلسلة زرقاء جديدة

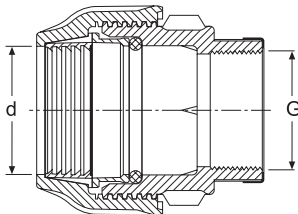

KOD CODE	EBAT/SIZE d x G	AMBALAJ ADEDİ PACKING QUANTITY	KOLİ ADEDİ BOX QUANTITY	ÇUVAL ADEDİ SACK QUANTITY
10008111	20 x 1/2"	50	700	750
10008112	20 x 3/4"	50	550	650
10008121	25 x 1/2"	25	450	500
10008122	25 x 3/4"	25	450	450
10008123	25 x 1"	25	350	400
10008132	32 x 3/4"	25	275	300
10008133	32 x 1"	25	250	275
10008134	32 x 1 1/4"	25	225	250
10008143	40 x 1"	15	150	180
10008144	40 x 1 1/4"	15	150	165
10008145	40 x 1 1/2"	15	135	150
10008154	50 x 1 1/4"	10	90	100
10008155	50 x 1 1/2"	10	90	100
10008156	50 x 2"	10	80	90
10008165	63 x 1 1/2"	6	54	60
10008166	63 x 2"	6	54	60
10008167	63 x 2 1/2"	6	48	48
10008176	75 x 2"	4	32	36
10008177	75 x 2 1/2"	4	32	32
10008178	75 x 3"	4	28	32
10008186	90 x 2"	4	16	20
10008187	90 x 2 1/2"	4	16	20
10008188	90 x 3"	4	16	20
10008189	90 x 4"	4	12	16
10008195	110 x 2"	2	12	16
10008196	110 x 2 1/2"	2	12	14
10008197	110 x 3"	2	12	14
10008198	110 x 4"	2	12	14



KOD CODE	EBAT/SIZE d x G x d	AMBALAJ ADEDİ PACKING QUANTITY	KOLİ ADEDİ BOX QUANTITY	ÇUVAL ADEDİ SACK QUANTITY
10008311	20 x 1/2" x 20	15	270	300
10008312	20 x 3/4" x 20	15	240	270
10008321	25 x 1/2" x 25	10	200	220
10008322	25 x 3/4" x 25	10	180	200
10008323	25 x 1" x 25	10	160	170
10008331	32 x 1/2" x 32	10	120	140
10008332	32 x 3/4" x 32	10	110	130
10008333	32 x 1" x 32	10	100	120
10008334	32 x 1 1/4" x 32	10	100	110
10008342	40 x 3/4" x 40	5	60	75
10008343	40 x 1" x 40	5	60	70
10008344	40 x 1 1/4" x 40	5	55	70
10008345	40 x 1 1/2" x 40	5	50	70
10008352	50 x 3/4" x 50	4	40	48
10008353	50 x 1" x 50	4	40	48
10008354	50 x 1 1/4" x 50	4	40	44
10008355	50 x 1 1/2" x 50	4	40	44
10008356	50 x 2" x 50	4	32	36
10008363	63 x 1" x 63	3	21	27
10008364	63 x 1 1/4" x 63	3	21	27
10008365	63 x 1 1/2" x 63	3	21	24
10008366	63 x 2" x 63	3	21	24
10008367	63 x 2 1/2" x 63	3	18	21
10008376	75 x 2" x 75	1	14	16
10008377	75 x 2 1/2" x 75	1	12	14
10008378	75 x 3" x 75	1	12	13
10008387	90 x 2 1/2" x 90	1	8	9
10008388	90 x 3" x 90	1	6	9
10008389	90 x 4" x 90	1	7	7
10008396	110 x 2 1/2" x 110	1	6	7
10008397	110 x 3" x 110	1	5	5
10008398	110 x 4" x 110	1	4	5



KABLİN DIŞI TE

FEMALE TEE

ТРОЙНИК С ВНУТРЕН.РЕЗ.

تي خرطوم سن داخلي

GALVANİZ METAL YÜZÜKLÜ

GALVANIZED REINFORCEMENT RING
Оцинкованное металлическое кольцо
حلقة معدنية مجلفنة سلسلة زرقاء جديدة

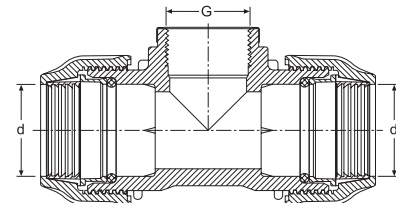



KABLIN DIŐI DİRSEK

FEMALE ELBOW

ОТВОД С ВНУТРЕ.РЕЗ.

زاوية خرطوم سن داخلي

GALVANİZ METAL YÜZÜKLÜ

GALVANIZED REINFORCEMENT RING

Оцинкованное металлическое кольцо

حلقة معدنية مجلفنة سلسلة زرقاء جديدة

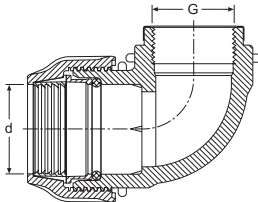

KOD CODE	EBAT/SIZE d x G	AMBALAJ ADEDİ PACKING QUANTITY	KOLİ ADEDİ BOX QUANTITY	ÇUVAL ADEDİ SACK QUANTITY
10008511	20 x 1/2"	25	550	600
10008512	20 x 3/4"	25	450	500
10008521	25 x 1/2"	15	360	390
10008522	25 x 3/4"	15	330	360
10008523	25 x 1"	15	270	300
10008532	32 x 3/4"	10	220	250
10008533	32 x 1"	10	180	220
10008534	32 x 1 1/4"	10	150	170
10008543	40 x 1"	5	120	130
10008544	40 x 1 1/4"	5	100	120
10008545	40 x 1 1/2"	5	90	100
10008554	50 x 1 1/4"	4	72	80
10008555	50 x 1 1/2"	4	60	68
10008556	50 x 2"	4	52	64
10008565	63 x 1 1/2"	4	40	52
10008566	63 x 2"	4	40	48
10008567	63 x 2 1/2"	4	32	40
10008576	75 x 2"	2	24	28
10008577	75 x 2 1/2"	2	20	28
10008578	75 x 3"	2	18	24
10008587	90 x 2 1/2"	1	14	18
10008588	90 x 3"	1	13	15
10008589	90 x 4"	1	10	14
10008597	110 x 3"	1	8	11
10008598	110 x 4"	1	8	10



KABLİN DİŞİ

FEMALE ADAPTOR

МУФТА С ВНУТРЕН.РЕЗБ

راس خرطوم سن داخلی

PASLANMAZ METAL YÜZÜKLÜ (AISI430)

STAINLESS STEEL REINFORCEMENT RING

кольцом из нержавеющей стали

المجموعة الزرقاء الجديدة معدن

اء الجديدة معدن غير قابل لآ

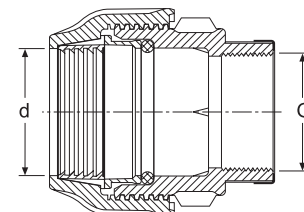

KOD CODE	EBAT/SIZE d x G	AMBALAJ ADEDİ PACKING QUANTITY	KOLİ ADEDİ BOX QUANTITY	ÇUVAL ADEDİ SACK QUANTITY
10007111	20 x ½"	50	700	750
10007112	20 x ¾"	50	550	650
10007121	25 x ½"	25	450	500
10007122	25 x ¾"	25	450	500
10007123	25 x 1"	25	350	400
10007132	32 x ¾"	25	275	300
10007133	32 x 1"	25	250	275
10007134	32 x 1 ¼"	25	225	250
10007143	40 x 1"	15	150	180
10007144	40 x 1 ¼"	15	150	165
10007145	40 x 1 ½"	15	135	150
10007154	50 x 1 ¼"	10	90	100
10007155	50 x 1 ½"	10	90	100
10007156	50 x 2"	10	80	90
10007165	63 x 1 ½"	6	54	60
10007166	63 x 2"	6	54	60
10007167	63 x 2 ½"	6	48	48
10007176	75 x 2"	4	32	36
10007177	75 x 2 ½"	4	32	32
10007178	75 x 3"	4	28	32
10007186	90 x 2"	4	16	20
10007187	90 x 2 ½"	4	16	20
10007188	90 x 3"	4	16	20
10007189	90 x 4"	4	12	16
10007195	110 x 2"	2	12	16
10007196	110 x 2 ½"	2	12	14
10007197	110 x 3"	2	12	14
10007198	110 x 4"	2	12	14



KABLİN DIŐİ TE

FEMALE TEE

ТРОЙНИК С ВНУТРЕН.РЕ.З.

تي خرطوم سن داخلي

PASLANMAZ METAL YÜZÜKLÜ (AISI430)

STAINLESS STEEL REINFORCEMENT RING

кольцом из нержавеющей стали

المجموعة الزرقاء الجديدة معدن

غير قابل للصدأ مع عصابة

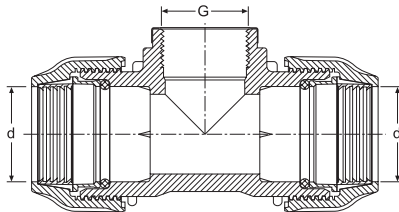

KOD CODE	EBAT/SIZE d x G x d	AMBALAJ ADEDİ PACKING QUANTITY	KOLİ ADEDİ BOX QUANTITY	ÇUVAL ADEDİ SACK QUANTITY
10007311	20 x 1/2" x 20	15	270	300
10007312	20 x 3/4" x 20	15	240	270
10007321	25 x 1/2" x 25	10	200	220
10007322	25 x 3/4" x 25	10	180	200
10007323	25 x 1" x 25	10	160	170
10007331	32 x 1/2" x 32	10	120	140
10007332	32 x 3/4" x 32	10	110	130
10007333	32 x 1" x 32	10	100	120
10007334	32 x 1 1/4" x 32	10	100	110
10007342	40 x 3/4" x 40	5	60	75
10007343	40 x 1" x 40	5	60	75
10007344	40 x 1 1/4" x 40	5	55	70
10007345	40 x 1 1/2" x 40	5	50	70
10007352	50 x 3/4" x 50	4	40	48
10007353	50 x 1" x 50	4	40	48
10007354	50 x 1 1/4" x 50	4	40	44
10007355	50 x 1 1/2" x 50	4	40	44
10007356	50 x 2" x 50	4	32	36
10007363	63 x 1" x 63	3	21	27
10007364	63 x 1 1/4" x 63	3	21	27
10007365	63 x 1 1/2" x 63	3	21	24
10007366	63 x 2" x 63	3	21	24
10007367	63 x 2 1/2" x 63	3	18	21
10007376	75 x 2" x 75	1	14	16
10007377	75 x 2 1/2" x 75	1	12	14
10007378	75 x 3" x 75	1	12	13
10007387	90 x 2 1/2" x 90	1	8	9
10007388	90 x 3" x 90	1	6	9
10007389	90 x 4" x 90	1	7	7
10007396	110 x 2 1/2" x 110	1	6	7
10007397	110 x 3" x 110	1	5	5
10007398	110 x 4" x 110	1	4	5

KOD CODE	EBAT/SIZE d x G	AMBALAJ ADEDİ PACKING QUANTITY	KOLİ ADEDİ BOX QUANTITY	ÇUVAL ADEDİ SACK QUANTITY
10007511	20 x ½"	25	550	600
10007512	20 x ¾"	25	450	500
10007521	25 x ½"	15	360	390
10007522	25 x ¾"	15	330	360
10007523	25 x 1"	15	270	300
10007532	32 x ¾"	10	220	250
10007533	32 x 1"	10	180	220
10007534	32 x 1 ¼"	10	150	170
10007543	40 x 1"	5	120	130
10007544	40 x 1 ¼"	5	100	120
10007545	40 x 1 ½"	5	90	100
10007554	50 x 1 ¼"	4	72	80
10007555	50 x 1 ½"	4	60	68
10007556	50 x 2"	4	52	64
10007565	63 x 1 ½"	4	40	52
10007566	63 x 2"	4	40	48
10007567	63 x 2 ½"	4	32	40
10007576	75 x 2"	2	24	28
10007577	75 x 2 ½"	2	20	28
10007578	75 x 3"	2	18	24
10007587	90 x 2 ½"	1	14	18
10007588	90 x 3"	1	13	15
10007589	90 x 4"	1	10	14
10007597	110 x 3"	1	8	11
10007598	110 x 4"	1	8	10



KABLİN DIŞI DİRSEK

FEMALE ELBOW

ОТВОД С ВНУТРЕ.РЕЗ.

زاوية خرطوم سن داخلي

PASLANMAZ METAL YÜZÜKLÜ (AISI430)

STAINLESS STEEL REINFORCEMENT RING

кольцом из нержавеющей стали

المجموعة الزرقاء الجديدة معدن

غير قابل للصدأ مع عصابة

